

Ellickson Steel Personnel Doors



Custom Made Quality Solutions.

STEEL PERSONNEL DOORS

Ellickson Doors Personnel Doorsets are uniquely designed to satisfy the requirements of modern architecture and provide ease of installation.

Ellickson Doors Personnel Doorsets and frames are manufactured to the highest quality standards using Computer Numeric Controlled machinery and state of the art manufacturing techniques.

Ellickson Doors patented design; high quality materials and precision engineering have resulted in our door not only being functionally superior, but also visually attractive.

Ellickson Doors provide fire rated Personnel Doorsets on request, all design features and components used in their construction are tested to comply with the requirements on BS 476 Part 22 1987, and BS EN1634-1 2000, by Warrington Fire Research Centre.

Technical Data

Door Panel:- Manufactured from 1.0mm Zinc Plated Mild Steel Skins seamed on two vertical edges and reinforced with bracing to form a rigid door leaf. The inner and outer door skins are bonded to a mineral core. The design gives superior strength and durability.

Door Frame:- Manufactured from 2mm Zinc Coated Mild Steel, incorporates a unique Ellickson Doors “Jacking Bolt” system. This allows for the door to be securely plumbed on two axes for ease of installation. Door Frame is complete with factory fitted smoke and draught seals.

Finish Options:- Personnel doorsets are supplied as standard in factory applied primer finish.
Powder coated finish available in standard RAL / BS colour.
Stainless steel finish available.

Ironmongery:- Ellickson Doors is factory fitted with tested ironmongery.

Options:-

- Lock – Lever/knob mortice lock & prepared for a euro profile cylinder
- Key / Thumb turn
- Lever Handle Set
- Pull Handle / Push Plate
- Emergency Exit Panic Latch – Single point of multi point contact
- Door Closers
- Door Hold Open Device
- Flush Bolts
- Security Bolts
- Kick Plates
- Vision Windows
- Louvred Panels
- Hatch Doors

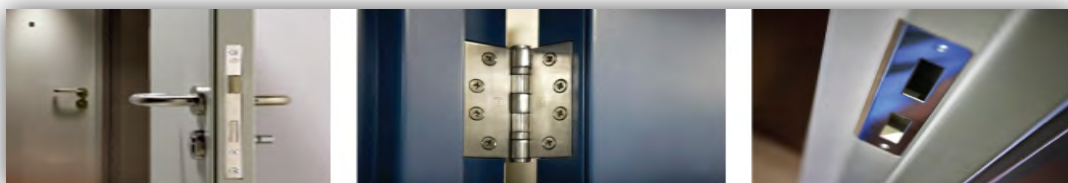

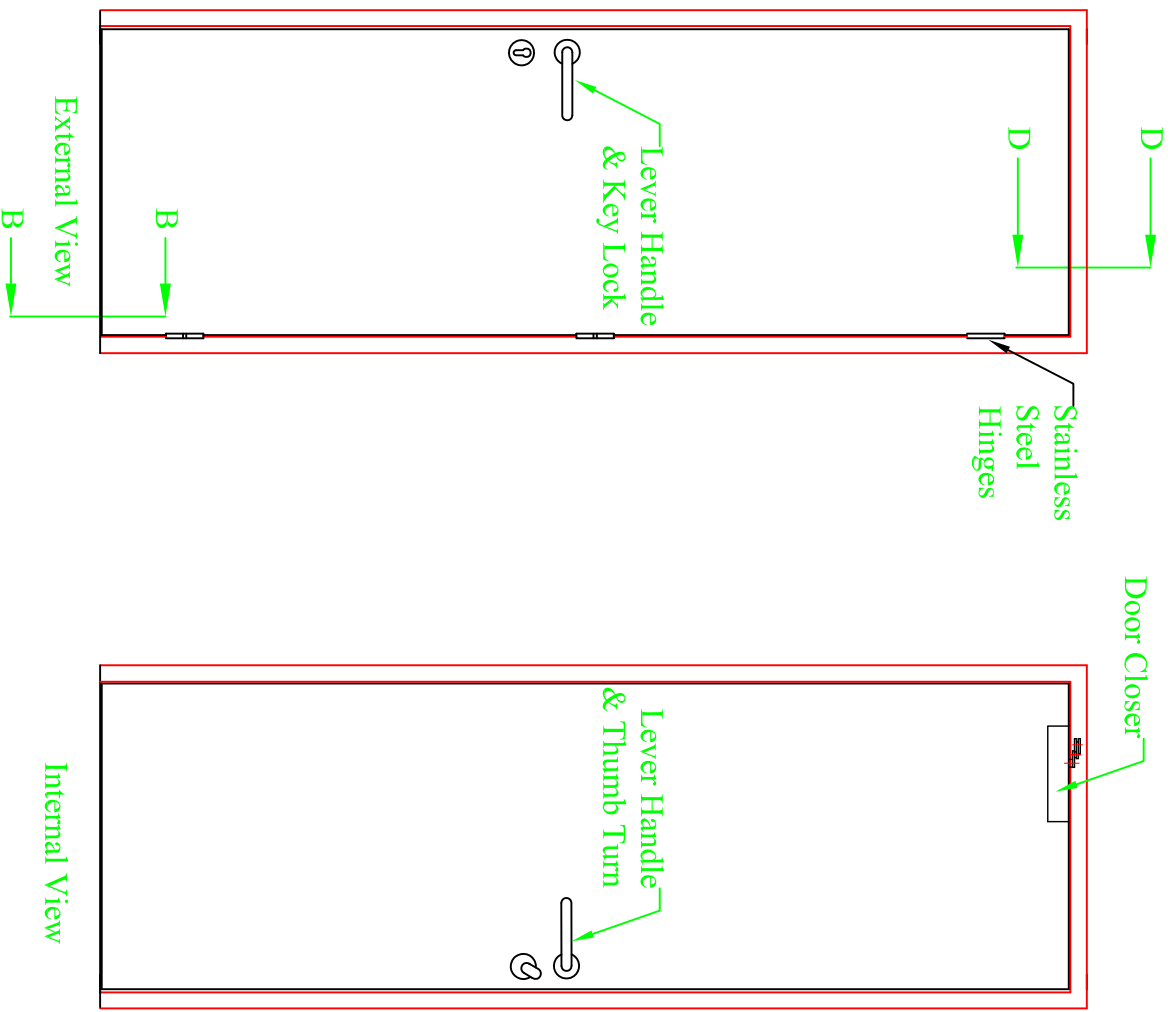



Door Ironmongery

Painted Finish:- Standard Ral
 Door Closers:- 1 No.
 Lever Handles:- 2 No.
 Keylock/Thumb Turn:- 1 No
 Hinges:- 3 No. SS Butt Hinges
 Door Frames:- 100mm Wide Standard

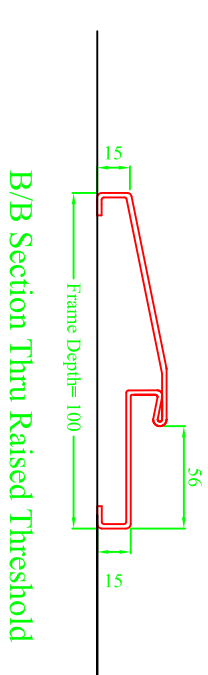
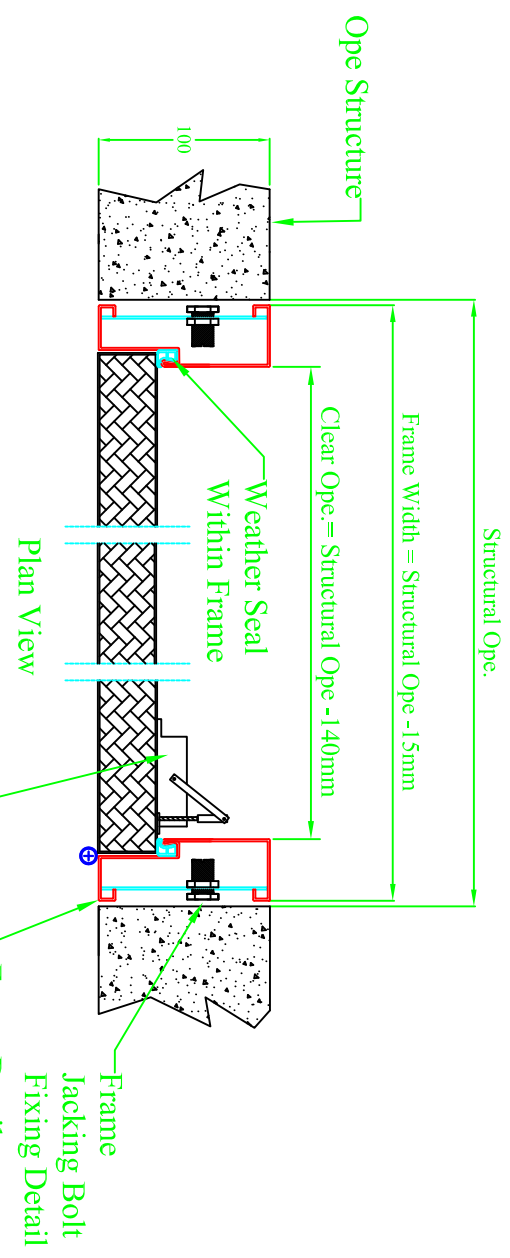
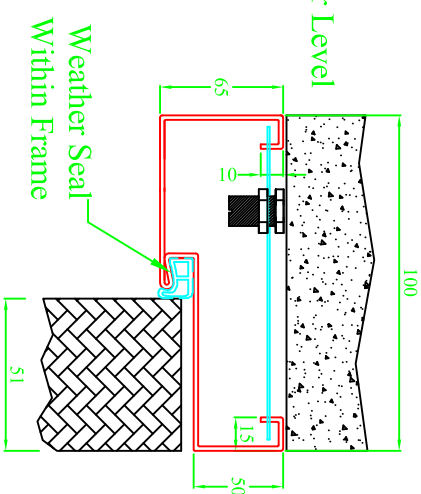
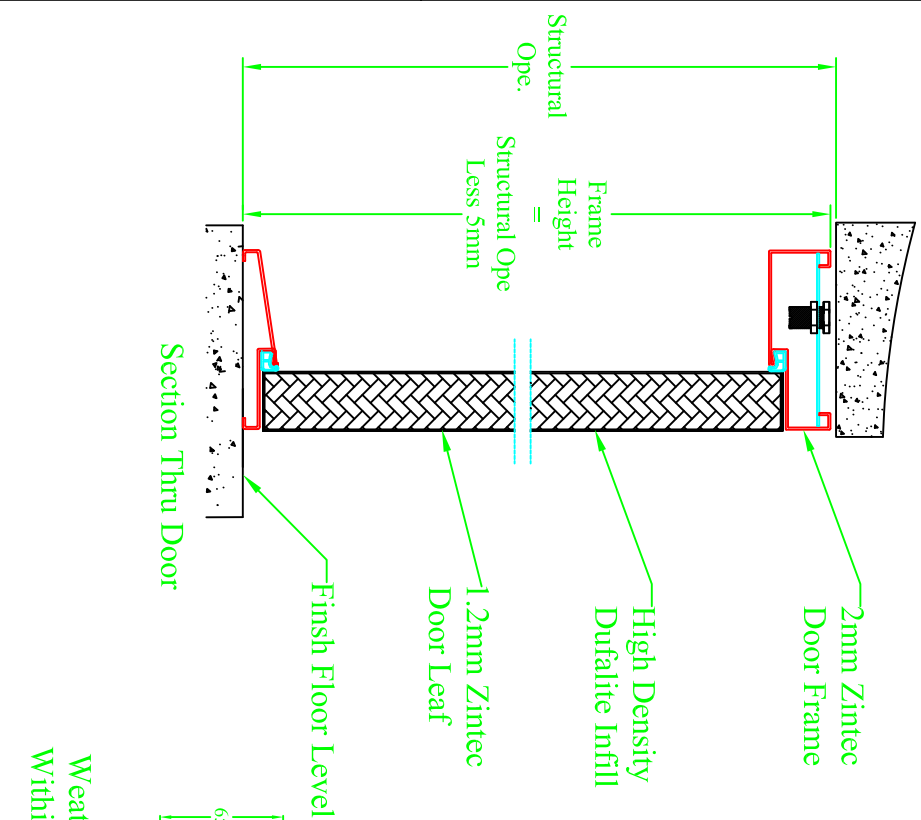
 <p>Unit: 17F, Six Cross Roads Business Park, Waterford TEL: 051-339451 MOB: 087 2899866, 087 2309843</p>		DRAWING TITLE Steel Personnel Doors	
UNLESS OTHERWISE SPECIFIED: DIMENSIONS ARE IN MILLIMETRES DO NOT SCALE DRAWING		STORAGE REFERENCE SD-EI-02	
DRAWN BY A O'Brien	DATE 21-4-11	JOB REFERENCE	
CHECKED BY			



Ellickson Doors
 SUPPLY • INSTALL • SERVICE
 Unit 17F, Six Cross Roads Business Park, Waterford
 TEL: 051-339451 MOB: 087 2809866, 087 2309843

UNLESS OTHERWISE SPECIFIED:
 DIMENSIONS ARE IN MILLIMETRES
 DO NOT SCALE DRAWING

DRAWING TITLE	Steel Personnel Doors	
DRAWING NO.	SD-EI-01	JOB REFERENCE
DRAWN BY	A O'Brien	DATE
CHECKED BY		21-4-11
STORAGE REFERENCE		

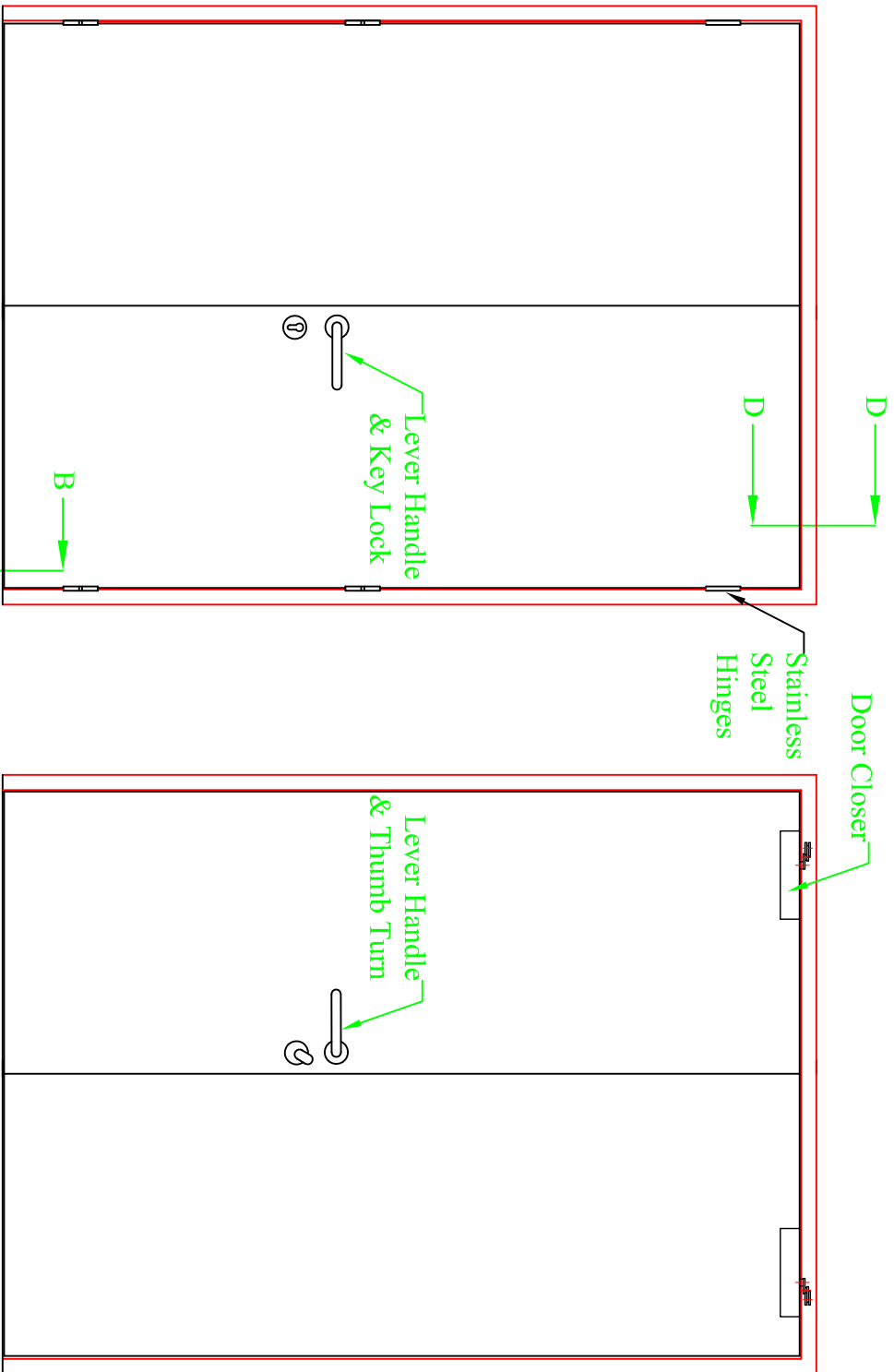

Door Ironmongery
Painted Finish:- Standard Ral
Door Closers:- 1 No.
Lever Handles:- 2 No.
Keylock/Thumb Turn:- 1 No
Hinges:- 3 No. SS Butt Hinges
Door Frames:- 100mm Wide Standard

External View

Internal View

 <p>Unit: 17F, Six Cross Roads Business Park, Waterford TEL: 051-338451 MOB: 087 2859886, 087 2309843</p>		<p>UNLESS OTHERWISE SPECIFIED: DIMENSIONS ARE IN MILLIMETRES DO NOT SCALE DRAWING</p>	
<p>DRAWING TITLE</p> <p>Steel Personnel Doors</p>		<p>STORAGE REFERENCE</p> <p>SD-BT-04</p>	
<p>DRAWN BY</p> <p>A O'Brien</p>		<p>DATE</p> <p>21-4-11</p>	
<p>CHECKED BY</p>		<p>JOB REFERENCE</p>	

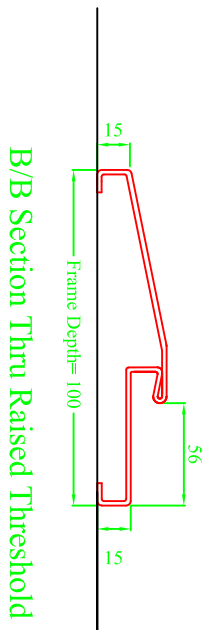
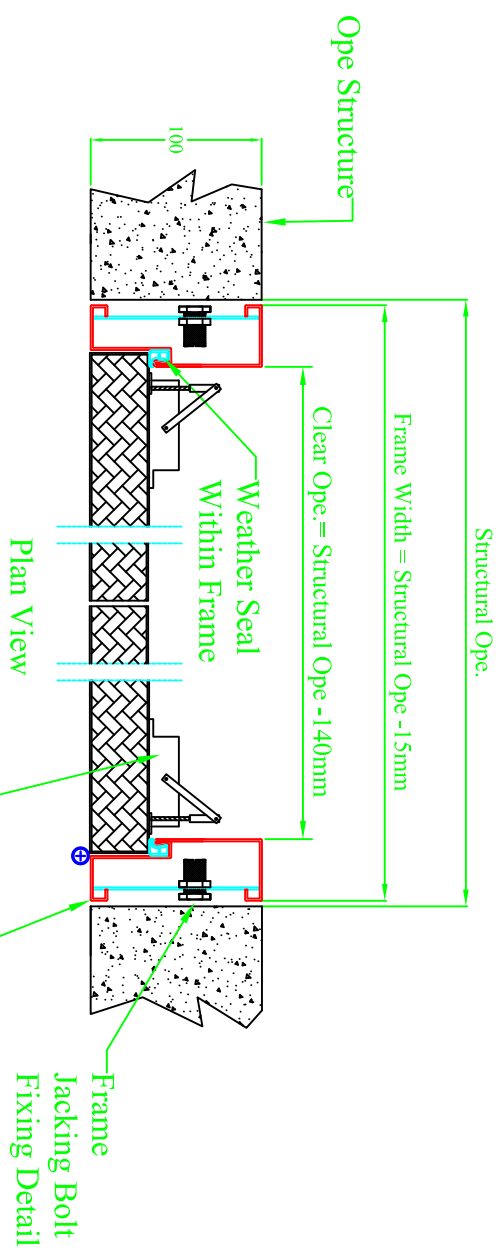
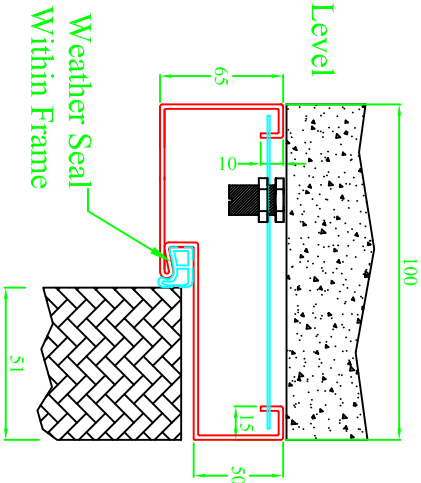
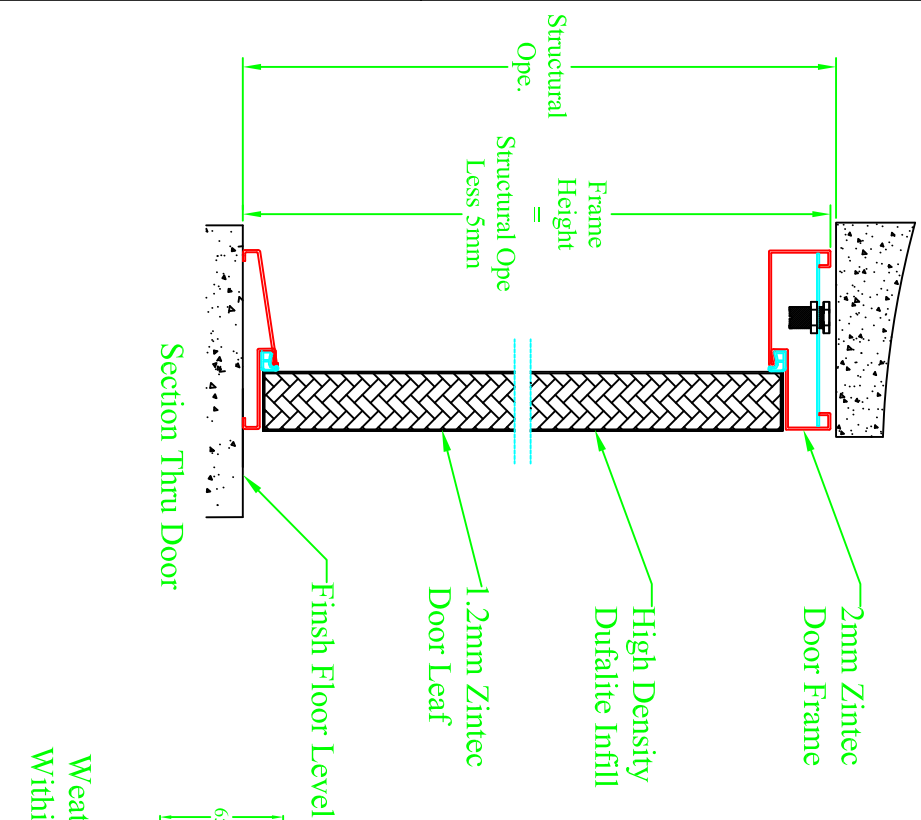

D/D Section Thru Head Frame

		Unit 17F, 5th Cross Roads Business Park, Waterford TEL: 051-339451 MOB: 087 2809866, 087 2309843	
UNLESS OTHERWISE SPECIFIED: DIMENSIONS ARE IN MILLIMETRES DO NOT SCALE DRAWING		DRAWING TITLE Steel Personnel Doors	
DRAWN BY A O'Brien		STORAGE REFERENCE SD-EI-03	
DATE 21-4-11		JOB REFERENCE	
CHECKED BY			